

CATEGORY	DESCRIPTION	P/N #
CONNECTOR	USB 3.0 A FEMALE 90° DIP	UB9SF-XXX11-ZRK001

REV.	ECN NO	DESCRIPTION	REVISED	DATE
A01		New Release	KELLY	2014.02.13

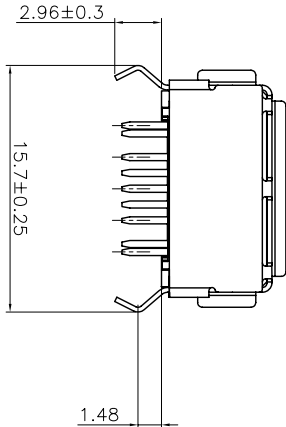
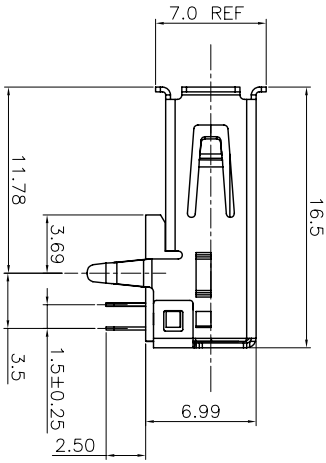
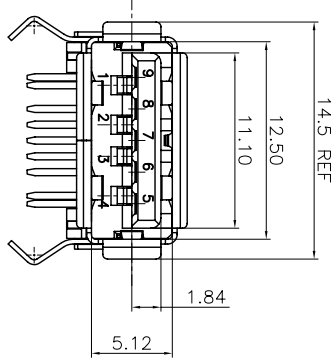
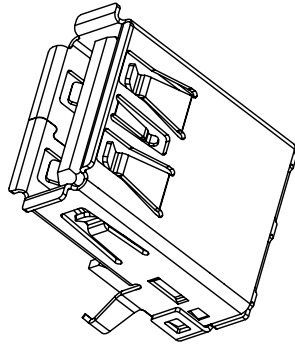
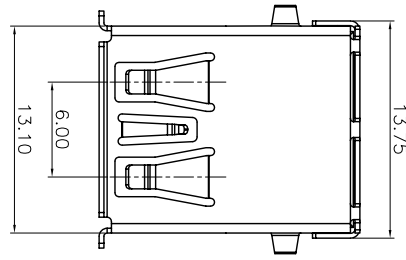

Table 1

X	屏蔽壳材质
C	Brass
S	Steel

Table 2

X	塑胶颜色区分
B	BLACK
W	WHITE
U	BLUE

Table 3

Material & Plating	
X	Terminal Plating
0	Au 1u" Plating
1	Au 3u" Plating
2	Au 6u" Plating
3	Au 15u" Plating
4	Au 30u" Plating

- NOTES:
1. MATERIAL:
- 1.1 HOUSING: HIGH TEMPERATURE THERAL PLASTIC.
  - 1.2 SPRING CONTACT: COPPER ALLOY.
  - 1.3 FLAT CONTACT: COPPER ALLOY
  - 1.4 SHELL : COPPER ALLOY
  - 1.5 COVER: HIGH TEMPERATURE THERAL PLASTIC.
2. FINISH:
- 2.1 CONTACT: (SEE P/N.): [50μm] MIN. NICKEL UNDERPLATING OVER ALL.
  - 2.2 SHELL: [50μm] MIN. SOLDERABILITY NICKEL UNDERPLATING OVER ALL.

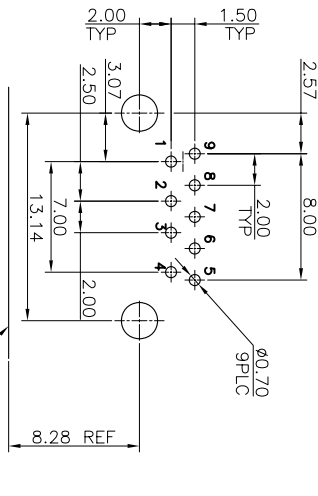
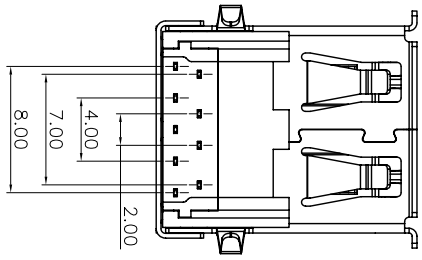

TOLERANCE: ±0.05,  
RECOMMENDED PCB LAYOUT  
(TOP VIEW)

POB EDGE

PIN NO.	PIN 5	PIN 6	PIN 7	PIN 8	PIN 9
SIGNAL NAME	STDA_SSRX-	STDA_SSRX+	GND_DRAIN	STDA_SSTX-	STDA_SSTX+
REMARK	USB 3.0 CONTACT PINS				

**东莞市合陵电子有限公司**  
DongGuan Heling Electronic Co., LTD

UNLESS OTHERWISE SPECIFIED TOLERANCES	SCALE: 1/1	UNIT: mm	DWG. NO:
DECIMALS: X : ±0.5	SIZE: A3	PAGE: 1 OF 1	REV: A01
ANGLES: X : ±2°	APPROVED BY	CHECKED BY	PREPARED BY
X.X : ±0.38	TNOY	BILL	KELLY
X.XX : ±0.25	CUSTOMER COPY		